



VACUUM OVEN
SVAC1 SVAC1-2
SVAC2 SVAC2-2
SVAC4 SVAC4-2

Previously designated as
1425, 1425-2
1445, 1445-2
1465, 1465-2

INSTALLATION AND OPERATION MANUAL

Revised 6 / 2014
4861531

Sheldon Manufacturing Inc. P.O. Box 627 Cornelius, Oregon 97113
EMAIL: tech@Shellab.com INTERNET: <http://www.Shellab.com/~Shellab>
1-800-322-4897 (503) 640-3000 FAX (503) 640-1366

TABLE OF CONTENTS

SECTION 1.0	RECEIVING AND INSPECTION
SECTION 2.0	GRAPHIC SYMBOLS
SECTION 3.0	INSTALLATION
SECTION 4.0	PRECAUTIONS
SECTION 5.0	CONTROL PANEL OVERVIEW
SECTION 6.0	VACUUM OPERATION
SECTION 7.0	OPERATION
SECTION 8.0	MAINTENANCE
SECTION 9.0	TROUBLESHOOTING
SECTION 10.0	PARTS LIST UNIT SPECIFICATIONS SCHEMATICS REFERENCE INFORMATION APPENDIX

These units are TUV CUE listed as vacuum ovens for professional, industrial or educational use where the preparation or testing of materials is done at approximately atmospheric pressure and no flammable, volatile or combustible materials are being heated. These units have been tested to the following requirements:

CAN/CSA C22.2 No. 61010-1:2012

CAN/CSA C22.2 No. 61010-2-010 + R:2009

UL 61010A-2-010:2002

UL 61010-1:2012

EN 61010-1:2010

EN 61010-2-010:2003

INTRODUCTION

Thank you for purchasing our product. We know that in today's competitive market place, customers have many choices when purchasing constant temperature equipment. We appreciate your choosing our quality product. Our continued reputation as a leading laboratory product manufacturer rests with each and every customer. Sheldon Manufacturing, Inc. stands behind our products and want to let you know we are here if you need us.

Before you use the unit, read this entire manual carefully to understand how to install, operate, and maintain the unit in a safe manner. Your satisfaction with the unit will be maximized as you read about its safety and operational features.

Keep this manual on-hand so it can be used by all operators of the unit. Be sure all operators of the unit are given appropriate training before you put the unit in service.

Note: Use the unit only in the way described in this manual. Failure to follow the guidelines and instructions in this manual may be dangerous and illegal.

General Safety Considerations

Your oven and its recommended accessories have been designed and tested to meet strict safety requirements.

For continued safe operation of your oven, always follow basic safety precautions including:

- Read this entire manual before using the oven.
- Be sure you follow any city, county, or other ordinances in your area regarding the use of this unit.
- Use only approved accessories. Do not modify system components. Any alterations or modifications to your incubator may be dangerous and will void your warranty.
- Always plug the unit's power cord into a grounded electrical outlet that conforms to national and local electrical codes. If the unit is not grounded, parts such as knobs and controls may conduct electricity and cause serious injury.
- Do not connect the unit to a power source of any other voltage or frequency beyond the range stated on the power rating on the data plate of the unit.
- Do not modify the power cord provided with the unit. If the plug does not fit an outlet, have a proper outlet installed by a qualified electrician.
- Avoid damaging the power cord. Do not bend it excessively, step on it, place heavy objects on it. A damaged cord can easily become a shock or fire hazard. Never use a power cord after it has become damaged.
- Do not position the equipment in such a manner as to make it difficult to disconnect power cord or coupler.
- Do not attempt to move the unit while in operation or before the unit has been allowed to cool.

RECEIVING AND INSPECTION

IMPORTANT: READ THIS INSTRUCTION MANUAL IMMEDIATELY.

Your satisfaction and safety require a complete understanding of this unit, including its proper function and operational characteristics. Be sure operators are given adequate training before attempting to put unit in service. **NOTE: This equipment must be used only for its intended application; any alterations or modifications will void your warranty.**

- 1.1 **Inspection:** The carrier, when accepting shipment, also accepts responsibility for safe delivery and is liable for loss or damage claims. On delivery, inspect for visible exterior damage. Note and describe on the freight bill any damage found and enter your claim on the form supplied by the carrier.
- 1.2 Inspect for concealed loss or damage on the unit itself, both interior and exterior. If any, the carrier will arrange for official inspection to substantiate your claim. Save the shipping crate until you are sure the unit has been delivered in good condition.
- 1.3 **Return Shipment:** If for any reason you must return the unit, contact your customer representative for authorization. Supply the complete data plate information when requesting return authorization. Please see the manual cover for information on where to contact customer service.
- 1.4 **Accessories:** Verify all of the equipment indicated on the Ship Kit list included with the unit. Carefully check all packaging before discarding. The model SVAC1 (1425) / SVAC1-2 (1425-2) is equipped with two (2) deep shelves and one (1) shallow shelf. The model SVAC2 (1445) / SVAC2-2 (144-25) is equipped with two (2) deep shelves, one (1) shallow shelf and four (4) adjustable feet. The model SVAC4 (1465) / SVAC4-2 (1465-2) is equipped with three (3) shelves and four (4) adjustable feet.

Recording Data Plate Information









Once you have determined the unit is free from damage, locate the data plate at the back of the unit. The data plate indicates your unit's model number and serial number. Record this information below for future reference.

Table 1. Data Plate Information

Model Number	
Serial Number	
Part Number	
Voltage	

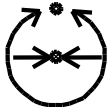
GRAPHIC SYMBOLS

Your oven has been provided with a display of graphic symbols which should help in identifying the use and function of the available user adjustable components.

Symbol	Identification
	Indicates that you should consult your operator's manual for further instructions. <i>Indique que l'opérateur doit consulter le manuel d'utilisation pour y trouver les instructions complémentaires.</i>
	Indicates "Temperature" <i>Repère "température"</i>
	Indicates "Overtemperature Protection" <i>Signale un "dépassement de température"</i>
	Indicates "AC Power" <i>Repère "secteur AC"</i>
	Indicates "Vent Valve" <i>Indique "clapet de mise à l'air libre"</i>
	Indicates "Vacuum Gauge" <i>Indique "jauge de vide"</i>
	Indicates "Manually Adjustable" <i>Signale un élément "réglable manuellement"</i>
	Indicates "Potential Shock Hazard" behind partition <i>Signale un "risque potentiel d'électrocution" au-delà de la cloison.</i>
	Indicates " Unit should be recycled " (Not disposed of in land-fill) <i>Indique "l'appareil doit être recyclé" (Ne pas jeter dans une décharge)</i>

INSTALLATION

Local city, county, or other ordinances may govern the use of this equipment. If you have any questions about local requirements, please contact the appropriate local agency. Installation may be performed by the end user.

Under normal circumstances these units are intended for use indoors, at room temperatures between 15° and 35°C, at no greater than 80% relative Humidity (at 25°C) and with a supply voltage that does not vary by more than 10%. Installation category is CAT-II Pollution Degree 2. Customer service should be contacted for operating conditions outside of these limits.

- 3.1 Power Source:** The unit power requirements are listed on the data plate. PLUG THE UNIT INTO A PROPERLY GROUNDED AND RATED RECEPTACLE OF THE CORRECT STYLE. **THE VOLTAGE OF THE RECEPTACLE SHOULD NOT VARY MORE THAN 10% FROM THE DATA PLATE RATING.** A separate circuit is recommended for this unit to prevent loss of product due to overloading or circuit failures caused by other equipment. Position the unit to allow user access to the power cord.
- 3.2 Location:** When selecting a site for the unit, consider conditions which may affect performance, such as heat from radiators, ovens, autoclaves, etc. Avoid direct sun, fast-moving air currents, heating/cooling ducts, and high-traffic areas. To ensure air circulation, allow a minimum of 30 cm between the unit and any walls or partitions which might obstruct free air flow.
- 3.3 Lifting / Handling:** These units are heavy and care should be taken to use appropriate lifting devices that are sufficiently rated for these loads. Units should only be lifted from their bottom surfaces. Doors, handles and knobs are not adequate for lifting or stabilization. The unit should be completely restrained from tipping during lifting or transport. All moving parts such as shelves and trays should be removed and doors need to be positively locked in the closed position during transfer to prevent shifting and damage.
- 3.4 Leveling:** The unit must sit level and solidly. Models SVAC1 (1425) and SVAC1-2 (1425-2) have four (4) rubber feet that are already attached to the unit and are not adjustable. Leveling feet are supplied with models SVAC2 (1445) / SVAC2-2 (144-25) and SVAC4 (1465) / SVAC4-2 (1465-2) and must be installed in the four holes at the base of the unit. With the unit standing upright, turn the leveling feet counterclockwise to raise the level of that corner. Adjust each foot until the unit stands solid and level. If the unit must be moved, turn the leveling feet in all the way to prevent damage while moving.
- 3.5 Cleaning:** The unit chamber should be cleaned and disinfected prior to use. The operating conditions and appropriate protocol will determine the correct procedure for decontamination. A typical decontamination procedure that is adequate for many situations has been described below. As well, certain steps are listed that will help reduce the likelihood of contamination and the necessity of decontamination. Whatever process is appropriate, it needs to be done on a regularly scheduled basis. Depending on usage and protocol, this may be monthly, quarterly or otherwise. Regardless of the decontamination procedure used, certain precautions will need to be taken:
 - A.** Always disconnect the unit from the electrical service when cleaning.
Assure all volatile or flammable cleaners are evaporated and dry before reconnecting the unit to the power supply.
 - B.** Special care should be taken when cleaning around sensing heads to prevent damage.
 - C.** Do not use chlorine-based bleaches or abrasive cleaners this will modify the stainless steel interior finish. **DO NOT USE** hard tools such as metal wire brushes or steel wool. Use non-abrasive cleaners and soft tools such as plastic brushes.
 - D.** In the event hazardous material is spilled onto or into the equipment, appropriate decontamination must be carried out. If there is any doubt about the compatibility of decontamination or cleaning agents with parts of the equipment or with material contained, please contact the manufacturer or his agent. No decontamination or cleaning agents should be used which could cause a hazard as a result of a reaction with parts of the equipment or with the material contained in it.
- 3.6 Shelves:** See Figure below. Place items on shelves. **DO NOT** place items directly on the floor of the chamber.

SHELF PLACEMENT AND DIMENSIONS

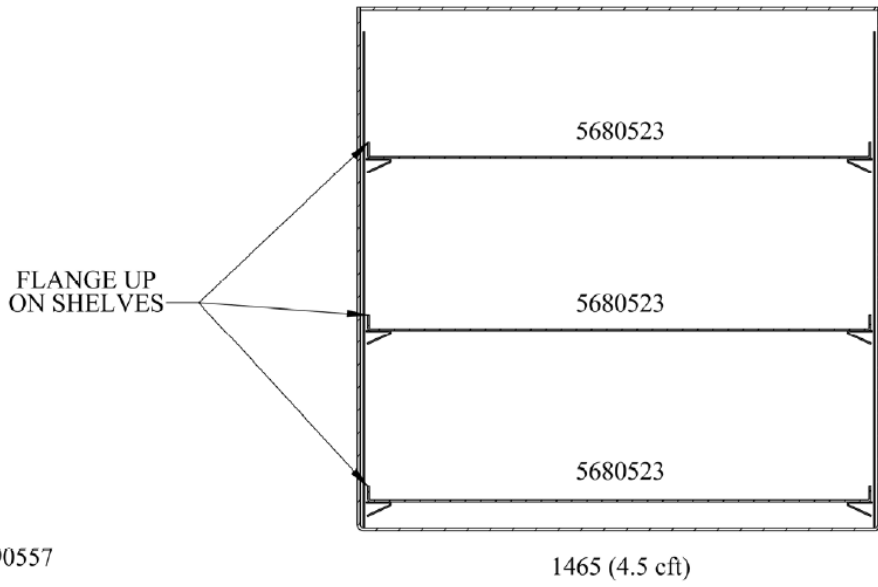
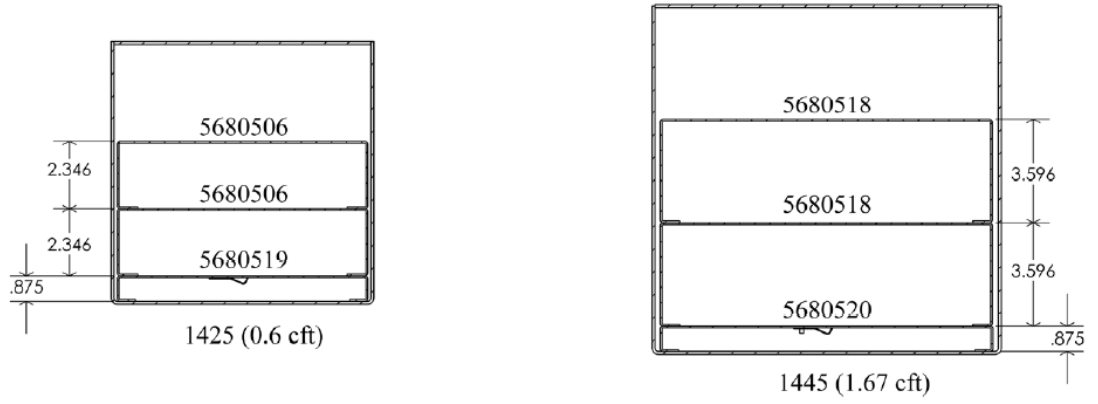

9890557

PRECAUTIONS

NOTE: THIS IS NOT AN EXPLOSION PROOF OVEN

- 4.1** The bottom surface of the chamber should not be used as a work surface.
- 4.2** Do not place or use explosive, combustible, or flammable materials in the oven.
- 4.3** Do not use sealed containers in the oven chamber.
- 4.4** Do not modify the power cord provided with the unit. If the plug does not fit an outlet, have a proper outlet installed by a qualified electrician.
- 4.5** Removal of any service panel or disconnect the unit from the electrical power source before attempting any repairs or component replacements should be done by approved trained service personnel.
- 4.6** If a mercury thermometer is used and breakage should occur, make sure **all** the spilled mercury is removed from the chamber.
- 4.7** This oven is **NOT** suitable for use in Class I, II, or III locations as defined in the National Electric Code of the United States of America, NFPA 70.
- 4.8** This oven is not intended, nor can it be used, as a patient connected device.

CONTROL PANEL OVERVIEW

SVAC1 (1425) & SVAC1-2 (1425-2)

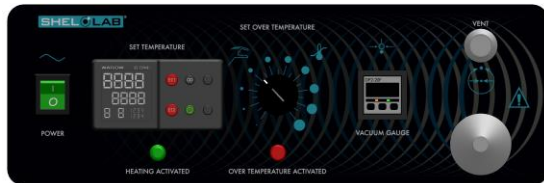

SVAC2 (1445) & SVAC2-2 (1445-2)
SVAC4 (1465) & SVAC4-2 (1465-2)

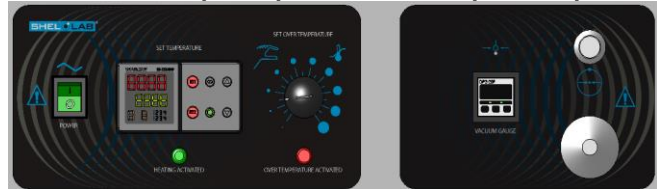

Watlow EZ-Zone Control

Watlow Controller Details

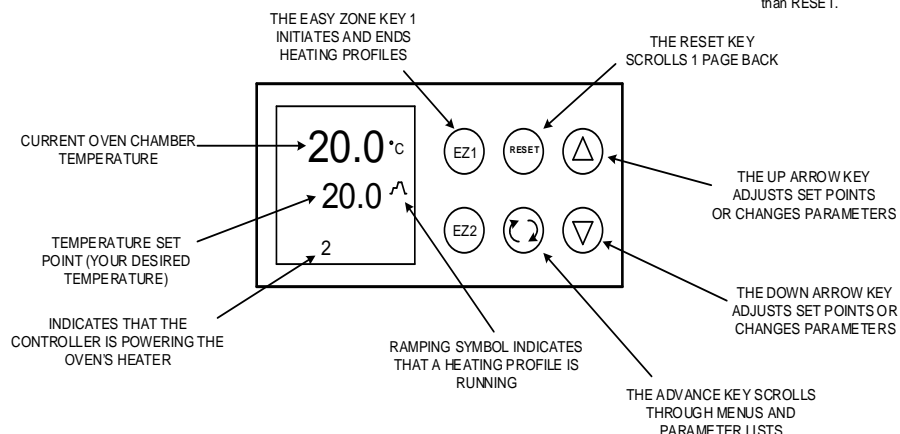

- 5.1 **POWER SWITCH:** This is the main power I/O (On/Off) switch. It must be in the ON position before any systems are operational.
- 5.2 **MAIN TEMPERATURE CONTROL:** The Main Temperature control is a Watlow EZ-Zone Controller consisting of the digital display and UP/DOWN arrow pads for adjusting set point temperatures and calibration, and four buttons for setting programs and parameters.
- 5.3 **HEATING LIGHT:** This green indicator light is on whenever the MAIN TEMPERATURE CONTROL has activated the heating elements to reach and maintain set point.
- 5.4 **SET OVER TEMPERATURE:** The Over Temperature Limit Control is completely independent of the MAIN TEMPERATURE CONTROLLER and guards against malfunctions which would allow temperature to rise past the Temperature set point. Setting adjustments for this control require a flat-edged tool to eliminate accidental changes. The control has a dial that is marked gradient scale and is adjustable across this scale. If the chamber temperature exceeds over the set point, the Set Over Temperature will limit the rise to approximately 10°C above the set point selected.
- 5.5 **OVER TEMPERATURE LIGHT:** This red indicator light is on whenever the temperature has exceeded the set point of the Over Temperature Limit Control and has activated and taken control of the oven. Under normal operating conditions this pilot light should never be on.

- 5.6 **FUSE:** Mounted on the rear wall next to the power cord, provides protection for the unit's electrical circuitry against over current conditions. The fuse, when blown, must be replaced before the unit can continue operation. Match the fuse ratings with those on the fuse data plate.
- 5.7 **VACUUM:** This adjustment handle allows opening and closing of the vacuum valve to an external vacuum pump or system.
- 5.8 **VENTILATION:** This adjustment handle controls the amount of ventilation to the chamber as when using a purge gas. This valve must be closed (completely clockwise) when the unit is in the vacuum mode.
- 5.9 **VACUUM GAUGE:** This digital gauge indicates the chamber operating vacuum. Your unit may be equipped with either a SUNX or Autonics device.

See Appendix for instructions on how to set the "unit" scale.

VACUUM OPERATION

- 6.1** The vacuum pump is the heart of your vacuum oven system. The selection of a vacuum pump is critical to match your overall performance expectations for time to evacuate the chamber and the maximum obtainable vacuum levels. As well, the type of pump should be considered depending on the material that will be placed in the chamber. Common types are Chemical Duty PTFE Dry, Standard Duty Dry, Compact Direct-Drive, and other specialty pumps for Corrosive gases. Selection of application specific pumps can improve the overall oven performance as the right pump ensures cost effectiveness and minimizes pump maintenance.

In general, a dry pump with a pumping capacity of 100 l/min. can be used to evacuate 840 liters volume (0.84 cubic meters) in a reasonable time. High vacuum pumps based on oil sealed rotary vane technology use the rule of thumb of 1 to 1.5 times the volume of space to determine pumping capacity (300 liters volume needs a 300 to 350 l/min. pump). The reason for the differing rule on oil sealed pumps is that the evacuation needs to be below 10torr in less than 10-15 minutes to avoid poor lubrication and overheating the internal pumping mechanism. Oil-free piston pumps don't overheat while evacuating larger chambers; however the time to maximum vacuum takes longer the smaller the pumping capacity.

- 6.2 IT IS IMPORTANT TO USE VACUUM TUBING FOR ALL THE VACUUM HOOKUPS. OTHER TYPES OF TUBING MAY COLLAPSE AND PREVENT COMPLETE EVACUATION.**

- 6.3 To Apply Vacuum to the Chamber:**

There are two ways to apply vacuum.

1. Attach the hose from the vacuum pump to the 3/8" hose connection on back of the oven. Close the VENTILATION valve (clockwise) and open the VACUUM valve. Latch the door shut and start the vacuum pump. This action will hold the door shut and against the gasket until the pump creates a vacuum in the chamber. Once a good vacuum seal is accomplished, the door will hold itself shut and sealed until the chamber is returned to ambient atmospheric pressure.
2. The unit is equipped with a KF-25 flanged 1" port. This can be used for faster, higher volume vacuum pump down. When the large port, close both the VENTILATION and VACUUM valves.

- 6.4** Watch the **VACUUM GAUGE** and when the required vacuum is obtained, close the vacuum valve and turn pump off. The digital vacuum gauge is factory set to display inches of mercury. The display will show 0—29.92 inch. If the vacuum exceeds 29.92, the display will show “_ _ _”. The 0 indication represents present atmospheric pressure. See Reference 2 for details for digital gauge settings.

- 6.5 Vacuum Release:** To return the chamber to ambient atmospheric pressure, open the VACUUM valve very slowly and allow the chamber to re-pressurize. The speed of pressurizing can be controlled by how much the valve is opened.

OVEN OPERATION

NOTE: When starting a new oven, allow the oven to operate two hours at 150°C. Slight vapor or smoke may occur in the initial heat-up. This is the dissipation of protective coatings that have been added to the oven elements.

7.1 Power Connection: Connect the service cord to a grounded outlet if supplied with a detachable cord set. Switch the unit to the ON position.

7.2 Turn the Set Over Temperature control to its maximum position (clockwise).

7.3 Setting the Main Temperature Control

Video is also available for instructions “Quick Start-Shel lab Vacuum Oven Basics.”

<http://www.shellab.com/store/virtual-tour-vac-oven.html>

To set the main temperature controller, perform the following steps:

1. Turn the power switch to the ON position. The Power ON Light will illuminate along with the Watlow PM Control.
2. Make sure the control is not running a program. If the Ramp Symbol is illuminated on the right side of the display, that means there is a program running. To turn off the program, push the EZ Key once. The Ramp Symbol should go off, indicating the program has ended. Enter the desired set point.

20.0
20.0



TO SET THE SETPOINT USE THE UP
ARROW TO RAISE THE VALUE OR
THE DOWN ARROW TO LOWER THE
VALUE IN THE BOTTOM DISPLAY

7.4 Calibrating the Main Temperature: It is recommended that calibration is done once the unit is installed in its working environment. The unit should be stable at set point for several hours and under vacuum. Once unit has been stable for several hours, compare process display with reference thermometer. After comparing the two figures out the calibration offset by subtracting the reference thermometer reading to the display reading. If the reference is greater than the display, it will be a positive number. If the reference is smaller than the display, it will be a negative number.

EXAMPLE:

<u>REFERENCE THERMOMETER</u>	<u>PROCESS DISPLAY</u>	<u>OFFSET CAL</u>
152°C	150°C	2
148°C	150°C	-2

Once the Offset Calibration Number is established, it can then be entered into the control. To enter into the control, push and hold both UP and DOWN Arrow Button simultaneously for three (3) seconds or until A1 appears in the Upper Display and Oper appears in the Lower Display. Then, push the Advance Key repeatedly until I.CA appears in the Bottom Display and a number value in the Upper Display. This number value can be changed by using the UP or DOWN Arrow Buttons. Change the number value to the Offset Calibration Number established earlier. If it is a negative number, you subtract. If it is a positive number, you add. Once the Offset Calibration Number is entered, push the Infinite Button repeatedly to exit to Home Page. (Process Temperature Display Top and Set Point Display Bottom.)

7.5 Setting the Set Over Limit Temperature Control:

To set the Over Temperature Limit Control, perform the following:

1. The Over Temperature Limit Control should be initially set to its maximum position to allow the Main Temperature Controller to stabilize.
2. Set Main Temperature Control to 1°C above desired set point and allow to stabilize.
3. Turn the Over Temperature Limit Control counter-clockwise until the Over Temperature Light just activated. Then, slowly turn the knob clockwise until the light goes out.
4. Return the Main Temperature Control back to desired set point.
5. This should set the Over Temperature Limit Control 1°C above Main Temperature Control. If the Over Temperature feature is being used, it is should be tested annually.

7.6 Digital Vacuum Gauge Setup: See Reference Section of the manual.

7.7 **Ramp and Soak Settings:** The Watlow EZ-Zone Controller is capable of 40-step ramp and soak profiles (or 40 different files-with 10 steps per file). The program will ramp up to 150° from ambient condition and soak for 4 hours. For your programs, make sure enough time is entered in the ramp time, so the oven can reach set point before entering the soak step. See Reference Section of the manual for more information.

Video is also available for instructions "How to Program Ramp & Soak Profiles."
<http://www.shellab.com/store/virtual-tour-vac-oven.html>

MAINTENANCE

Warning: *Prior to any maintenance or service on this unit, disconnect the power cord from the power supply. Before reattaching the unit to its power supply, be sure all volatile and flammable cleaners are evaporated and dry.*



Avertissement: *Avant d'effectuer toute maintenance ou entretien de cet appareil, débrancher le cordon secteur de la source d'alimentation. Avant de reconnecter l'appareil sur le secteur, s'assurer que tous les produits de nettoyage volatiles et inflammables sont complètement évaporés.*



Cleaning

The unit chamber should be cleaned and disinfected prior to use.

Periodic cleaning is required. To clean the incubator, perform the following steps:

1. Remove all of the interior parts, if assembled.
2. Clean the incubator with a mild soap and water solution, including all corners. DO NOT USE spray cleaners that might leak through openings and cracks and get on electrical components, or that may contain solvents that will harm coatings. DO NOT USE chlorine-based bleaches or abrasives, as they will damage the stainless steel interior.
3. Rinse with distilled water and wipe dry with a soft cloth.
4. Special care should be taken when cleaning around the sensing heads to prevent damage.

Disinfecting

Disinfect the incubator on a regular basis. To disinfect the incubator, perform the following steps.

1. Remove all of the interior parts, if assembled.
2. Disinfect the incubator, including all corners and the access port, using a suitable disinfectant. Shelves and shelf clips are autoclaveable. DO NOT USE spray disinfectants that might leak through openings and cracks and get on electrical components, or that may contain solvents, corrosives, or abrasives that will harm the stainless steel coatings. Special care should be taken when cleaning around sensing heads to prevent damage and around the door gasket so as not to impair the positive seal.
3. If a hazardous material/substance has been spilled in the unit, immediately initiate your site's Hazardous Material Spill Containment protocol. Contact your local Site Safety Officer and follow instructions per the policy and procedures established for your site.
4. There are many commercially available disinfectants available that are non-corrosive and non-abrasive and suitable for use on stainless steel surfaces. Contact your local Site Safety Officer for detailed information for the proper disinfectants suitable for your operation.

Warning: *Never clean the unit with alcohol or flammable cleaners and assure all volatile or flammable cleaners are evaporated and dry before reattaching the unit to the power supply.*



Avertissement: *Ne jamais nettoyer l'appareil à l'alcool ou avec des nettoyeurs inflammables et veiller à ce que les produits volatils ou inflammables soient entièrement évaporés avant de rebrancher le content d'alimentation de l'appareil.*



Periodically inspect the door latch, trim, catch and gasket for signs of deterioration. Failure to maintain the integrity of the door system will shorten the life span of the incubator.

No maintenance is required on electrical components. If the incubator fails to operate as specified, please review the Troubleshooting Section prior to calling for service.

TROUBLESHOOTING AND SERVICE

TEMPERATURE

Temperature too high

- 1/ controller set too high
- 2/ controller failed on-call Customer Service
- 3/ wiring error-call Customer Service

Display reads "HI" or "400"+

probe is unplugged, is broken or wire to sensor is broken-call Customer Service

Chamber temperature spikes over set point and then settles to set point

Recalibrate to desired temperature set point

Temperature too low

- 1/ Set Over Temperature too low
- 2/ Main control set too low
- 3/ unit not recovered from door opening – wait for display to stop changing
- 4/ unit not recovered from power failure or being turned off
- 5/ element failure – see if Heating light is on
- 6/ Main controller failure – confirm with front panel lights that controller is calling for heat
- 7/ Set Over Temperature failure – confirm with front panel lights Set Over Temperature is operating correctly
- 8/ wiring problem-check all functions. If not solved-call Customer Service

Display reads "LO"

- 1/ if ambient room temperature is lower than range of unit-compare set points and ambient temperature to rated specifications in section 9.0, Unit Specifications.
- 2/ Main sensor is plugged in backwards-call Customer Service.

Unit will not heat over a temperature that is below set point

- 1/ confirm that Set Over Temperature Control set point is set above the Main Temperature set point.
- 2/ check calibration-using independent thermometer

Unit will not heat up at all

- 1/ verify that controller is asking for heat by looking for Heating light-if pilot light is not on continuously during initial start up, there is a problem with the controller-call Customer Service.
- 2/ do all controller functions work?
- 3/ is the Set Over Temperature Control set high enough?-for diagnostics, should be fully clockwise with the Over Temperature light never on
- 4/ has the fuse blown? Check fuse at inlet.
- 5/ Units will need at least some vacuum in chamber to keep unit air tight-verify with Vacuum Gauge is above "0".

Indicated chamber temperature unstable

- 1/ ± 1 . may be normal.
- 2/ is ambient room temperature radically changing-either door opening or room airflow from heaters or air conditioning? -stabilize ambient conditions.
- 3/ calibration sensitivity-call Customer Service.

	<ul style="list-style-type: none"> 4/ Controller set too low—be sure that it is more than 5 degrees over desired set point; check if Over Temperature light is on continuously; turn controller knob completely clockwise to see if problem solved then follow instructions in section 6.6 for correct setting. 5/ electrical noise—remove nearby sources of RFI including motors, arcing relays or radio transmitters.
Will not maintain set point	<ul style="list-style-type: none"> 1/ assure that set point is at least 5 degrees over ambient room temperature 2/ see if ambient room temperature is fluctuating
Display and Reference thermometer don't match	<ul style="list-style-type: none"> 1/ calibration error—recalibrate. 2/ Main temperature sensor failure—evaluate if Heating light is operating correctly 3/ Main controller failure—evaluate if Heating light is operating correctly 4/ allow at least two hours to stabilize 5/ verify that reference thermometer is certified
Can't adjust set points or calibration	<ul style="list-style-type: none"> 1/ turn entire unit off and on to reset 2/ if repeatedly happens—call Customer Service
Calibrated at one temperature, but not at another	<p>This can be a normal condition when operating temperature varies widely. For maximum accuracy, calibration should be done as close to the set point temperature as possible.</p>

MECHANICAL

Glass door not sealing	Check physical condition of gasket—replace if worn.
Outer door not sealing	<ul style="list-style-type: none"> 1/ see if hinges are out of adjustment 2/ Confirm that unit has not been damaged and body out of square.
Oven won't hold vacuum	<ul style="list-style-type: none"> 1/ check door gasket for damage, wear or lack of compliance 2/ assure all vent and feed valves are closed tightly 3/ assure tight connections to pump

OTHER

Controller on at all times—"locked-up"	<ul style="list-style-type: none"> 1/ turn unit off and on to reset 2/ if cannot change any condition on the front panel—call Customer Service
Wall fuse/circuit breaker is blown	<ul style="list-style-type: none"> 1/ check wall power source 2/ see what other loads are on the wall circuit
Unit will not turn on	<ul style="list-style-type: none"> 1/ check wall power source 2/ check fuse/circuit breaker on unit or in wall 3/ see if unit is on, e.g., heater, and just controller is off 4/ check all wiring connections, esp. around the on/off switch.
Unit is smoking—Out of box	<p>This is common during initial operation. Put unit under vent and run at full power for two hours.</p>
Contamination in chamber	<ul style="list-style-type: none"> 1/ see cleaning procedure in operator's manual 2/ develop and follow standard operating procedure for specific application; include definition of cleaning technique and maintenance schedule

SERVICE

If this product should require service, contact Customer Service (800) 322-4897 or tech@Shellab.com. If return of the product is necessary, an authorization number must be obtained and the product shipped according to your representative, to the proper service center. To insure prompt handling, the return authorization number should be placed on the outside of the package or container. Make sure a detailed explanation of the reason for return is enclosed with the item.

PARTS LIST

Description	100-120V	220-240V
Controller Knob	4450506	4450506
Outer Door Glass		
SVAC1 (1425) & SVAC1-2 (1425-2)	3550522	3550522
SVAC2 (1445) & 1445-2	3550521	3550521
SVAC4 (1465) & SVAC4-2 (1465-2)	3550523	3550523
Door Glass		
SVAC1 (1425) & SVAC1-2 (1425-2)	3550542	3550542
SVAC2 (1445) & SVAC2-2 (1445-2)	3550540	3550540
SVAC4 (1465) & SVAC4-2 (1465-2)	3550586	3550586
Elements		
SVAC1 (1425) SVAC1-2 (1425-2) sides	9570867	9570867
SVAC1 (1425) SVAC1-2 (1425-2) bottom	9570860	9570860
SVAC2 (1445) SVAC2-2 (1445-2)sides	9570843	9570843
SVAC2 (1445) SVAC2-2 (1445-2)bottom	9570858	9570858
SVAC4 (1465) & SVAC4-2 side/top	9570883	9570883
SVAC4 (1465) & SVAC4-2 bottom	9570884	9570884
SVAC4 (1465) & SVAC4-2 side w/ probe	9570912	9570912
EMI Filter, 10A	2800502	2800502
EMI Filter, 20A SVAC4 (1465)	2800503	N/A
Fuse, T16A 250V	3300513	3300513
Fuse Holder	3300501	3300501
Door Gasket SVAC1 & SVAC1-2 9X9 inch red silicon	3450630	3450630
Door Gasket SVAC2 & SVAC2-2 12 X 12 red silicon	3450707	3450707
Door Gasket SVAC4 & SVAC4-2 18 X 18 red silicon	3450719	3450719
I/O Switch	7850570	7850570
Pilot Light, green	4650554	4650554
Pilot Light, red	4650553	4650553
Power Cord	1800510	1800539 (US) 1800500 (EURO)
Probe		
SVAC1 (1425), SVAC1-2 (1425-2)	6600519	6600519
SVAC4 (1465) & SVAC4-2 (1465-2)	6600519	6600519
SVAC2 (1445) & SVAC2-2 (1445-2)	6600536	6600536
Safety Controller	1750648	1750648

Continued on next page

Description	100-120V	220-240V
Temperature Controller (Watlow)		
SVAC1 (1425) & SVAC1-2 (1425-2)	9660501	9660501
SVAC2 (1445) & SVAC2-2 (1445-2)	9660502	9660502
SVAC4 (1465) & SVAC4-2 (1465-2)	9660503	9660503
Vacuum Gauge (Digital) Sunx	7850583	7850583
Vacuum Gauge (Digital) Autonics	7850584	7850584
Ventilation Valve	9990736	9990736
Vacuum Valve	9990737	9990737

UNIT SPECIFICATIONS

Weight	Shipping	Net
SVAC1 (1425)	145 lbs.	105 lbs.
SVAC1-2 (1425-2)	65.771 kg	47.627 kg
SVAC2 (1445)	220 lbs.	179 lbs.
SVAC2-2 (1445)-2	99.790 kg	81.193 kg
SVAC4 (1465)	400 lbs.	360 lbs.
SVAC4-2 (1465-2)	181.44 kg	163.29 kg

Dimensions	Exterior W x D x H	Interior W x D x H
SVAC1 (1425)	18 x 23 x 23.5 (in)	9 x 20 x 9 (in)
SVAC1-2 (1425-2)	45.72 x 58.42 x 69.69 (cm)	22.86 x 30.48 x 22.86 (cm)
SVAC2 (1445)	20.5 x 39.50 x 26.25 (in)	12 x 20 x 12 (in)
SVAC2-2 (144-25)	52.07 x 77.47 x 66.68 (cm)	30.48 x 50.80 x 30.48 (cm)
SVAC4 (1465)	26.5 x 34.5 x 32.25 (in)	18 x 24 x 18 (in)
SVAC4-2 (1465-2)	67.31 x 87.63 x 81.92 (cm)	45.72 x 60.96 x 45.72 (cm)

Capacity	Cubic Feet	Liter
SVAC1 (1425)	.56	15.93
SVAC1-2 (1425-2)		
SVAC2 (1445)	1.67	47.19
SVAC2-2 (144-25)		
SVAC4 (1465)	4.5	127.43
SVAC4-2 (1465-2)		

Vacuum Specifications	
Vacuum Range	In Hg (-3.0 to -29.9), kPa (-010 to -101), mbar (-101 to -1010)
Display Vacuum range (Display Resolution)	In Hg (0 to 29.9), kPa (5 to -101), mbar (0.05 to -1.013)
-29.92 inches Hg	10 mtorr
Maximum Permitted END Vacuum	10 mtorr
Leak Rate	10 mtorr/hour

Temperature	Range	Stability
All Models	Amb. +10° to 220°C	.2°C

MODEL	VOLTS	AMPS	CYCLE
SVAC1 (1425)	110-120 VAC	7.0 A	50/60hz
SVAC1-2 (1425-2)	220-240 VAC	4.5 A	50/60hz
SVAC2 (1445)	110-120 VAC	10 A	50/60hz
SVAC2-2 (1445-2)	220-240 VAC	5.5 A	50/60hz
SVAC4 (1465)	110-120 VAC	13 A	50/60hz
SVAC4-2 (1465-2)	220-240 VAC	7.0 A	50/60hz

WIRE DIAGRAM SVAC1 (1425) 100-120V 9851330

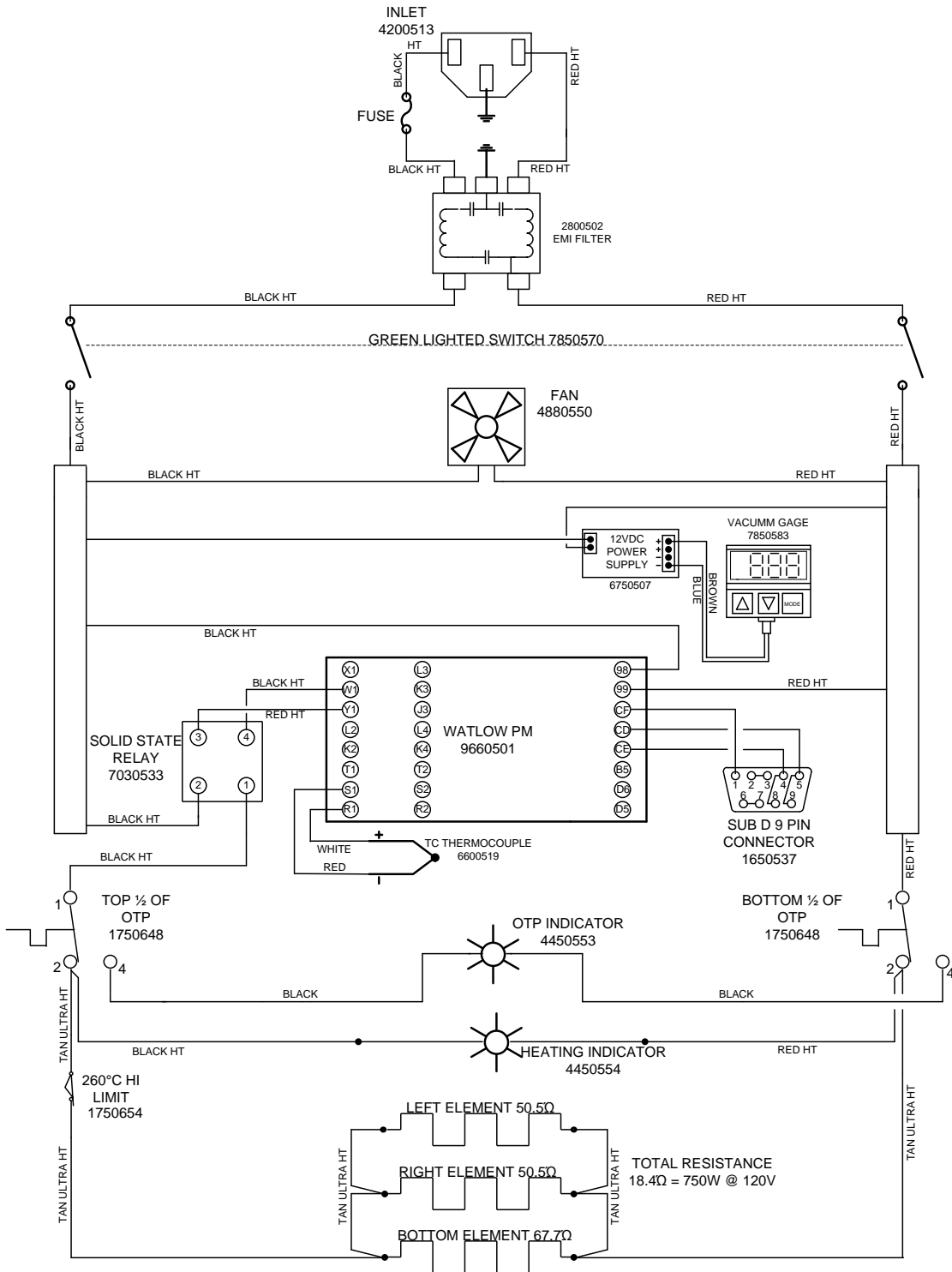

WIRE DIAGRAM

SVAC1-2 (1425-2) 220-240V

9851329

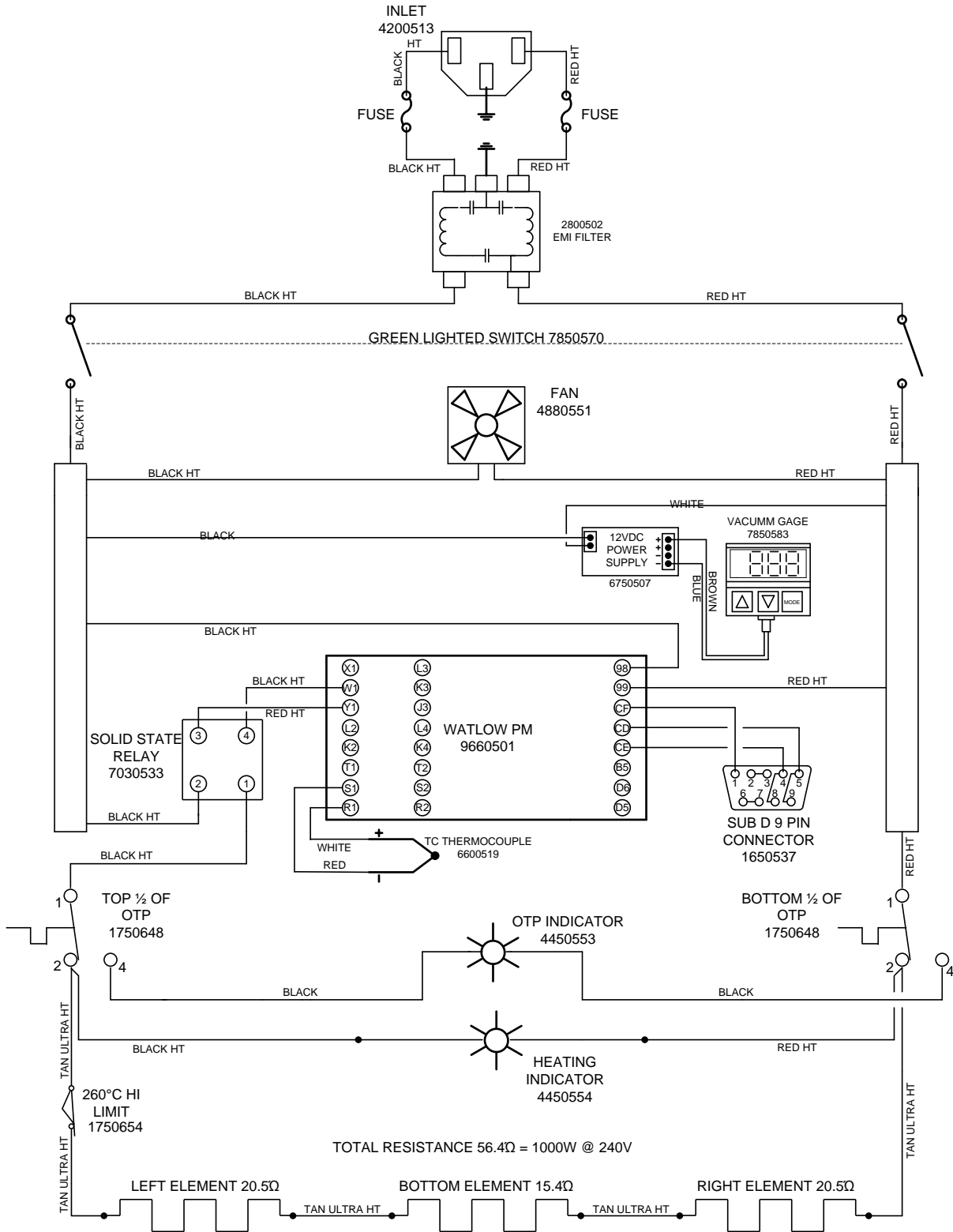

WIRE DIAGRAM

SVAC2 (1445) 100-120V

9851328

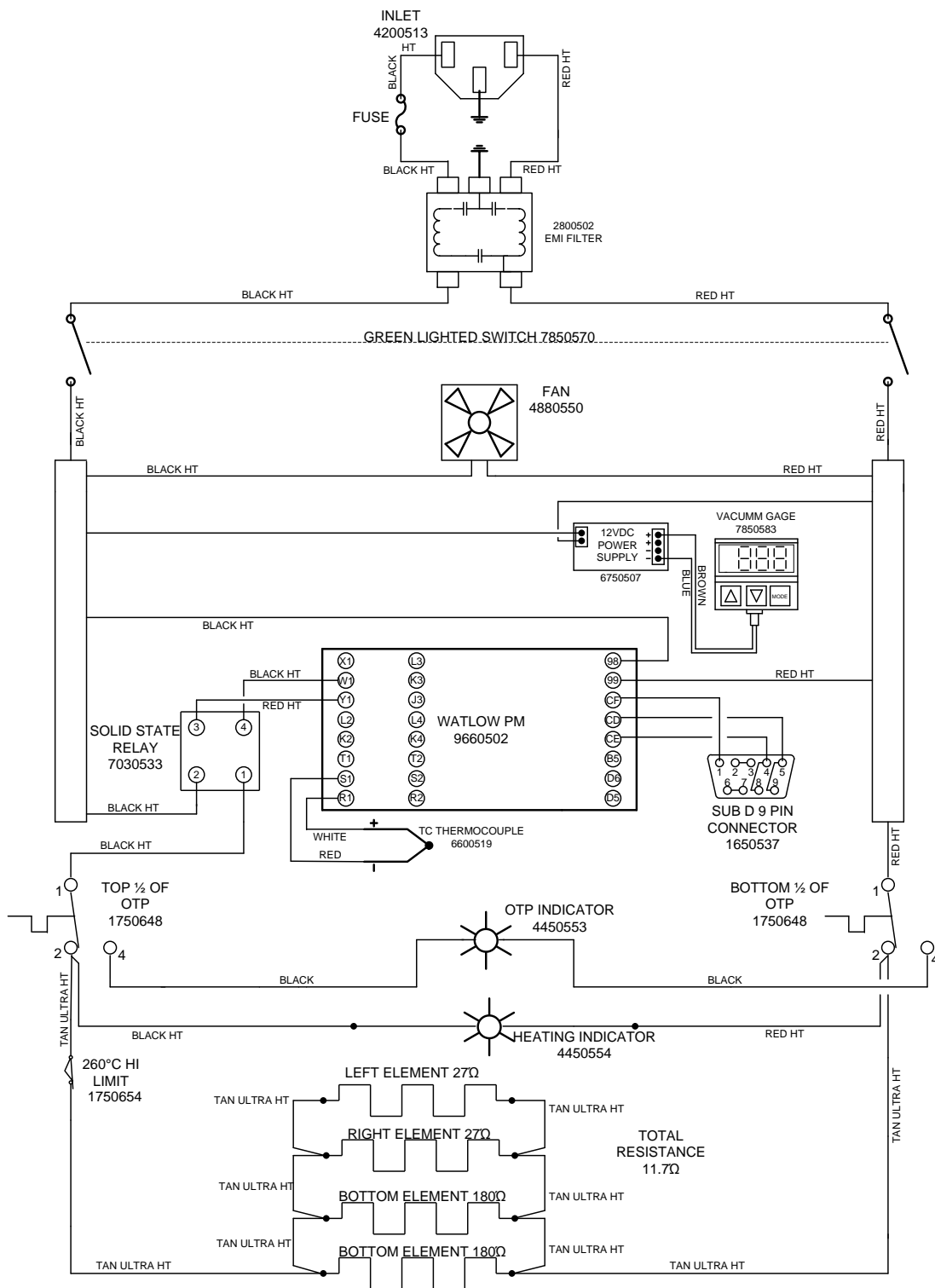

WIRE DIAGRAM

SVAC2-2 (144-25)220-240V

9851327

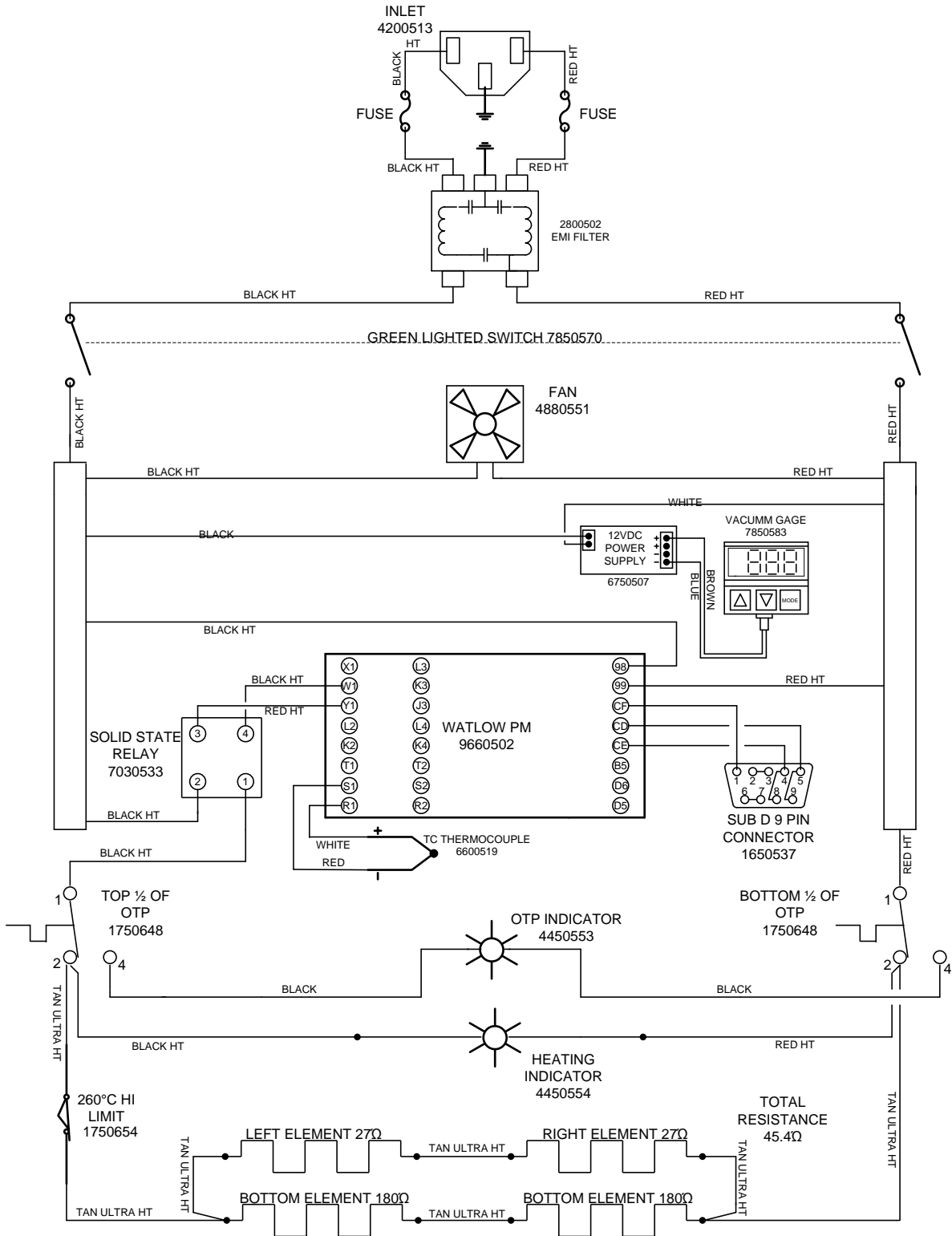

WIRE DIAGRAM SVAC4 (1465) 100-120V 9851326

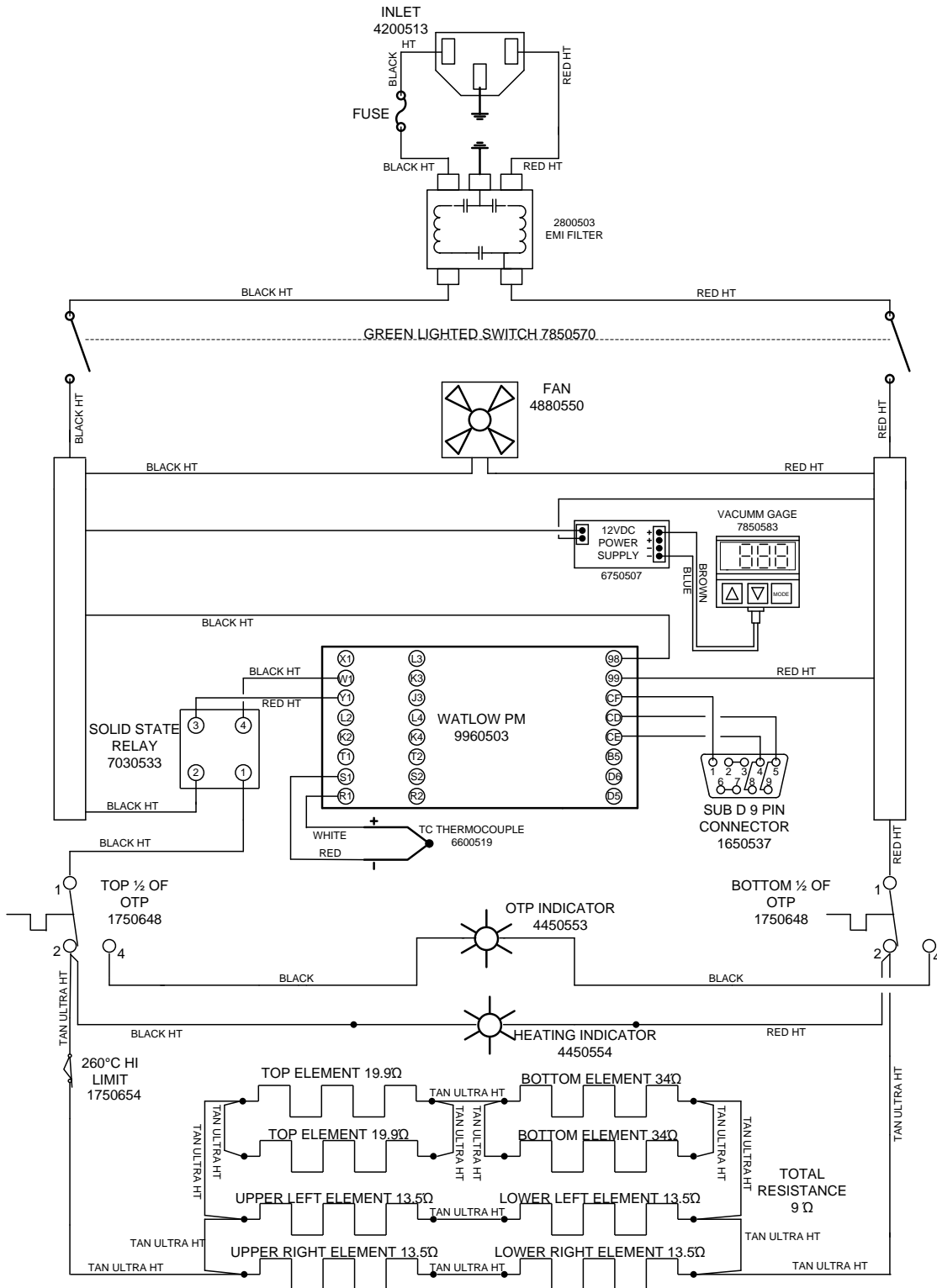

WIRE DIAGRAM

SVAC4-2 (1465-2) 220-240V

9851325

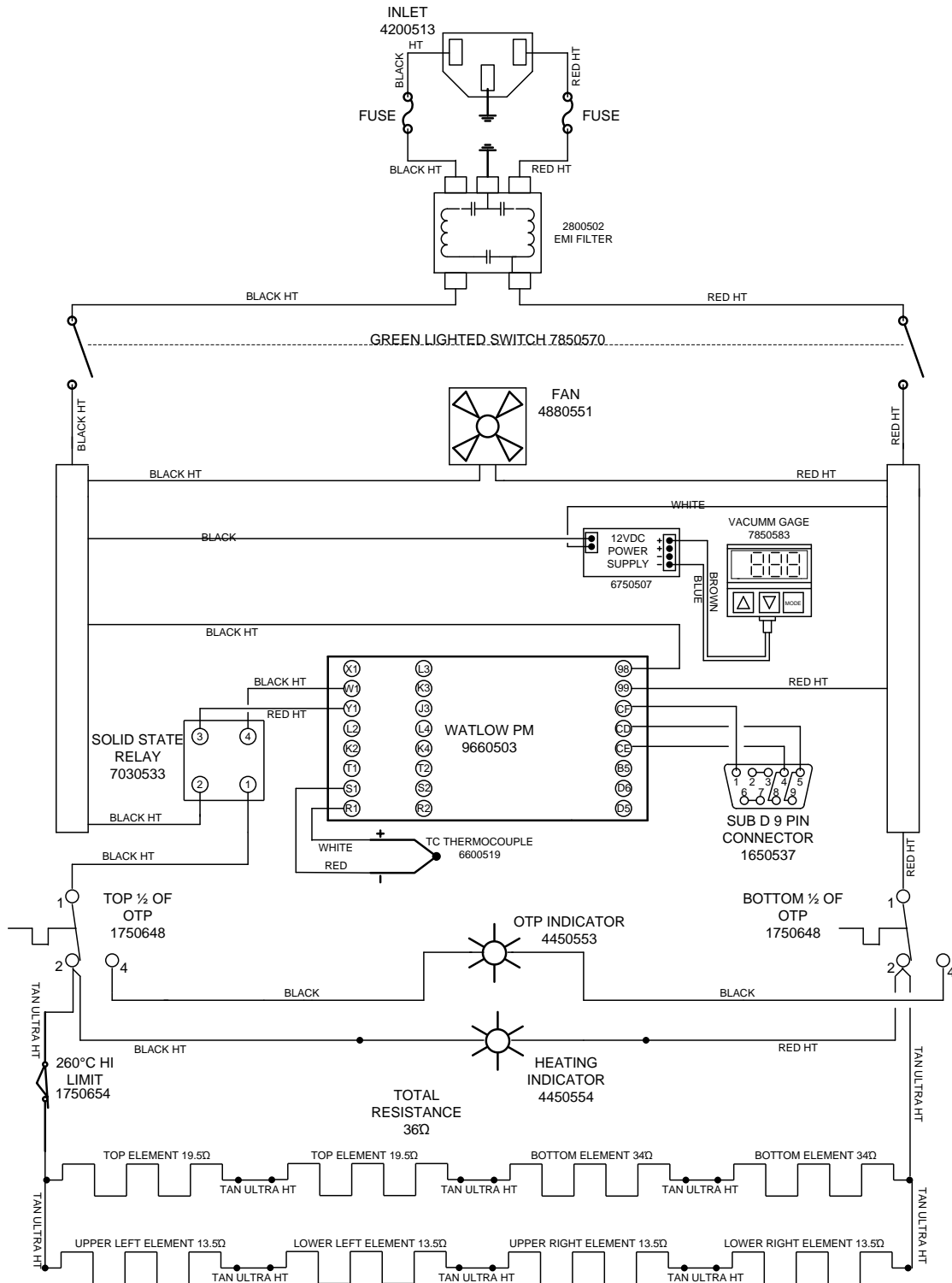

REFERENCE 1

PROGRAMING RAMP AND SOAK PROFILE

THE WATLOW EZ ZONE CONTROLLER IS CAPABLE OF 40 STEP RAMP AND SOAK PROFILES OR 4 DIFFERENT FILES WITH 10 STEPS PER FILE. BELOW IS A SIMPLE EXAMPLE PROGRAM ON HOW TO ENTER A PROFILE AND START AND RUN A PROGRAM. THE PROGRAM WILL RAMP UP TO 150 DEGREES FROM AMBIENT CONDITION AND SOAK FOR 4 HOURS. FOR YOUR PROGRAMS, MAKE SURE ENOUGH TIME IS ENTERED IN THE RAMP TIME SO THE OVEN CAN REACH SET POINT BEFORE ENTERING THE SOAK STEP. FOR EXAMPLE: IF THE OVEN TAKES 1 HOUR TO HEAT UP TO 150 DEGREES AND YOU ENTER A RAMP TIME OF 30 MINUTES IT WILL CUT DOWN THE SOAK TIME BY 30 MINUTES.

HOW TO ENTER THE PROGRAM

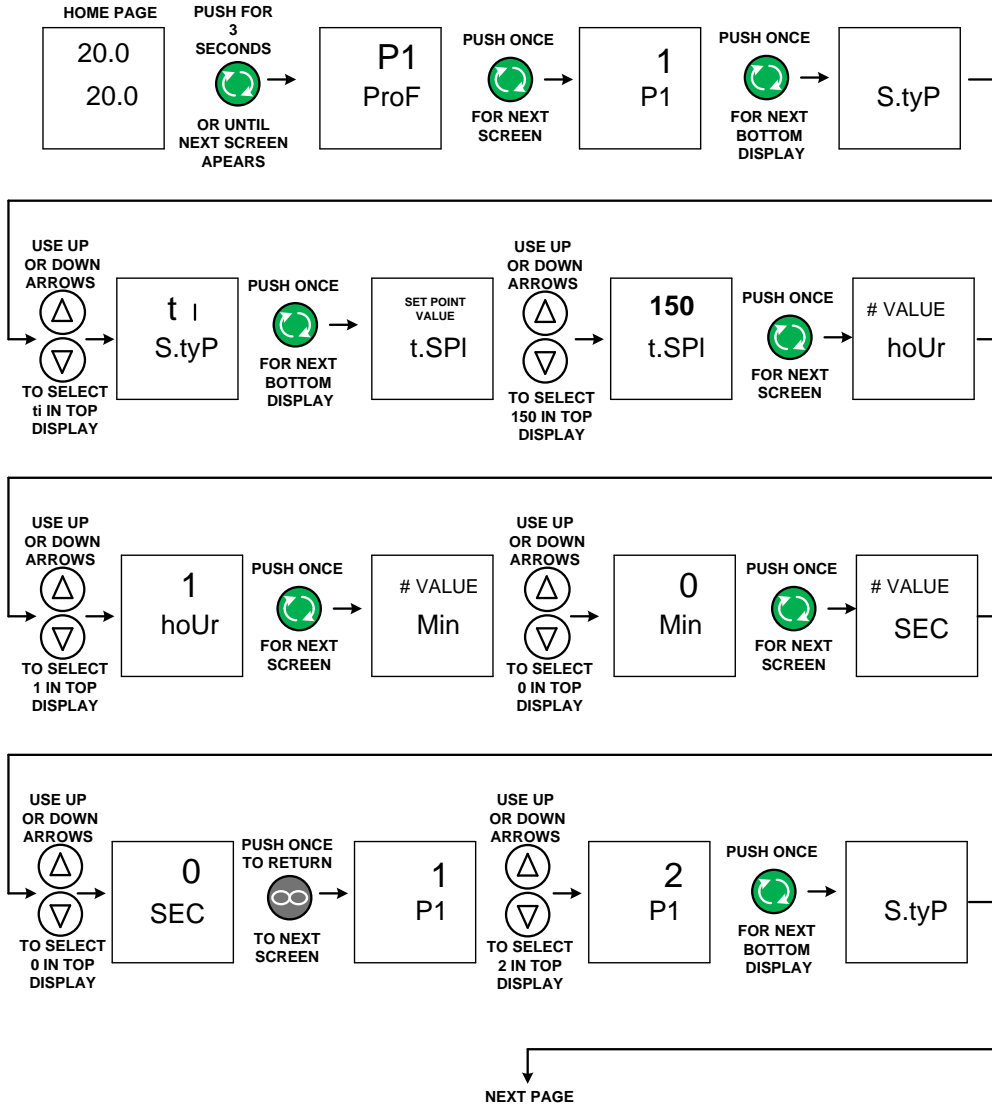

REFERENCE 1 (cont.)

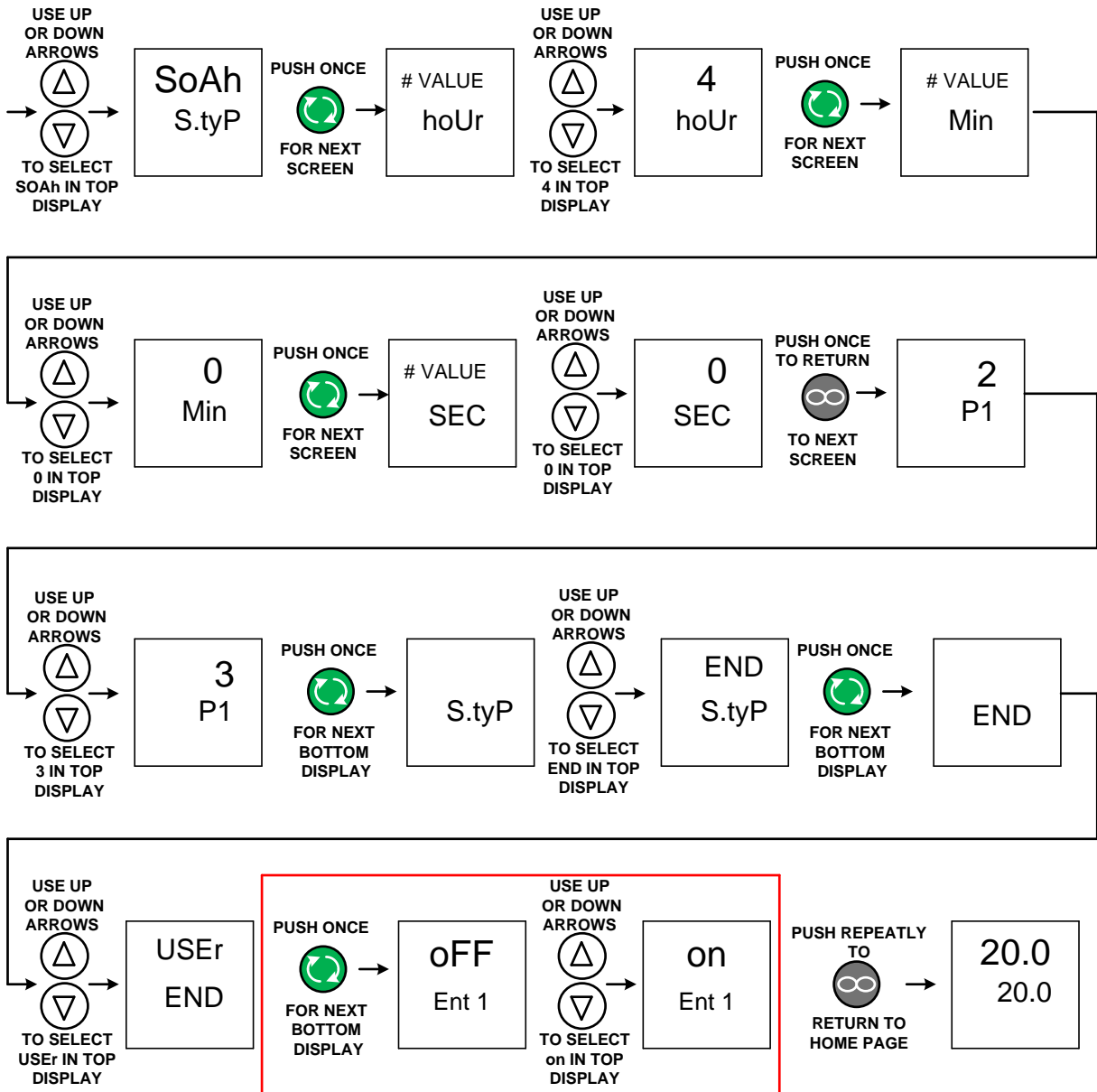

THIS SECTION IS ONLY FOR UNITS THAT IS EQUIPPED WITH POWER EXHAUST OUTLET

TO START THE PROGRAM PUSH THE EZ1 BUTTON ONCE. A RAMP SYMBOL WILL APPEAR ON THE RIGHT SIDE OF THE DISPLAY INDICATING THAT THE PROGRAM IS RUNNING. TO STOP THE PROGRAM PUSH THE EZ1 BUTTON AGAIN AND THE RAMP SYMBOL WILL DISAPPEAR AND THE SET POINT WILL RETURN TO SET VALUE BEFORE STARTING PROGRAM. WHEN PROGRAM HAS COMPLETED IT WILL AUTOMATICALLY RETURN TO ORIGINAL SET POINT VALUE BEFORE PROGRAM STARTED. UNITS EQUIPPED WITH POWER EXHAUST OUTLETS THE OUTLET WILL BE ACTIVE WHEN PROGRAMS ENDS.

REFERENCE 1 (cont.)

EXAMPLE GRAPH OF PROGRAMED PROFILE WITH 1 HOUR TIME TO TEMPERATURE AND 4 HOURS SOAK AT TEMPERATURE

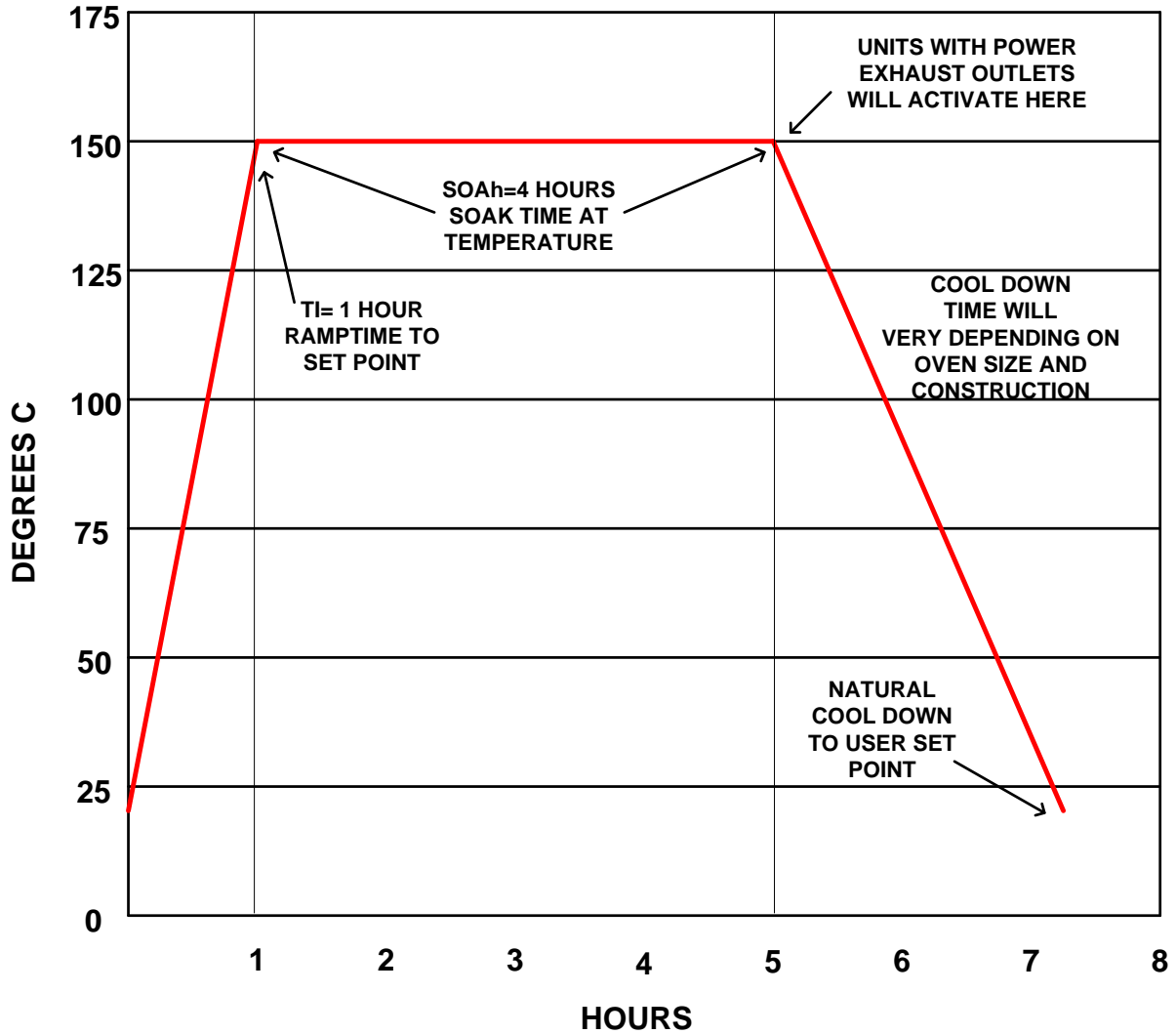

REFERENCE 2

SUNX VACUUM GAUGE

ZERO ADJUSTMENT: The **SUNX DP2-20F** vacuum gauge comes preset from the factory reading vacuum in inhg and automatically runs in sensing mode when powered on. At different altitudes the gauge may need to be re-zeroed. Without pressure applied and vacuum door open exposing the gauge to atmospheric pressure it should read 0.0. If not, zero the gauge by pressing and holding both up and down arrows simultaneously until the display reads zero then release the buttons and it should return to sensing mode automatically and read zero.

CHANGING VACUUM SCALES: The vacuum gauge can be set to indicate in several different units of vacuum. Below is a list of the different units of vacuum that can be selected with the corresponding display code.

UNITS VACUUM	DISPLAY LETTER
KPA	P
KGF/CM2	J
BAR	b
PSI	S
MMHG	H
INHG	I

The setup parameters are identified in by a three digit letter code. The first digit represents analog or digital. The second digit determines the output settings. The third digit determines the vacuum unit scale.

EXAMPLE

FIRST DIGIT	SECOND DIGIT	THIRD DIGIT
d	d	I

To change the vacuum units, press the mode button while pressing the up arrow button until the display reads ldd where the first digit d is flashing. Use the up arrow key to scroll trough each digit until the I digit is flashing. Select vacuum unit scale from the list above and change the display letter that corresponds to the vacuum units by pressing the down arrow. After the correct display letter is chosen press the mode key once to return to sensing mode. Changing the first and second digit letter will effect the way the vacuum gage functions and should be left reading dd.

SETTING OUTPUTS: The vacuum gauge comes with two outputs. These outputs are not used and are not hooked up to do anything. The gauge is used to indicate vacuum only. To set the outputs so the LED light indicator will not activate on the gauge press the mode key (MODE) once and the display should flash between P-1 and a value. Press the up arrow until the display reads UP and then press the mode key (MODE) once and the display should flash between P-2 and a value. Press the up arrow key until the display reads UP and then press the mode key (MODE) once to return to sensing mode.

REFERENCE 2 (cont.)

AUTONICS VACUUM GAUGE

ZERO ADJUSTMENT: The **AUTONICS PSA-V01** vacuum gage comes preset from the factory reading vacuum in inhg and automatically runs in sensing mode when powered on. Do to different altitudes the gage may need to be zeroed. Without pressure applied and vacuum door open exposing the gauge to atmospheric pressure it should read 0.0. If not zero the gauge by pressing and holding both up and down arrows simultaneously until the display reads zero than release the buttons and it should return to sensing mode automatically and read zero.

SETTING OUTPUTS: The vacuum gauge comes with two outputs. These outputs are not used and are not hooked up to do anything. The gauge is used to indicate vacuum only. To set the outputs so the LED light indicator will not activate on the gauge press the mode key (M) once and the display should flash between ST1 and a value. Press the up arrow until the display reads HI and then press the mode key (M) once and the display should flash between ST1 and a value. Press the up arrow key until the display reads HI and then press the mode key (M) once to return to sensing mode.

CHANGING VACUUM SCALES: The vacuum gauge can be set for several different units of vacuum. Below is a list of the different units of vacuum that can be chosen from. And there corresponding display code.

UNITS VACUUM	DISPLAY
KPA	PA
KGF/CM2	UGF
BAR	BAR
PSI	PSI
MMHG	AAH
INHG	I NG
MMH2O	H2O

To change the units of vacuum press and hold the mode (M) button for three seconds or until the display flashes between unit and vacuum unit scale code. Press the up or down arrow to change the vacuum unit scale code. To exit press and hold the mode (M) key for 3 seconds or until returned to sensing mode.

FACTORY SETUP PARAMETERS	
UNIT	INH
OUT	F---3
SPD	2.5
A-1	0.0
A-5	29.9
UNL	PEY

REFERENCE 3

APPENDIX

Conversion table for pressure units

	kPa	MPa	kgf/cm ²	bar	psi	mmHg (Torr)	inHg	atm
1 kPa	1	1 × 10 ⁻³	1.01972 × 10 ⁻²	1 × 10 ⁻²	1.45038 × 10 ⁻¹	7.50062	0.2953	9.86923 × 10 ⁻³
1 MPa	1 × 10 ³	1	1.01972 × 10	1 × 10	1.45038 × 10 ²	7.50062 × 10 ³	0.2953 × 10 ³	9.86923
1 kgf/cm ²	9.80665 × 10	9.80665 × 10 ⁻²	1	9.80665 × 10 ⁻¹	1.42234 × 10	7.35559 × 10 ²	2.8959 × 10	9.67841 × 10 ⁻¹
1 bar	1 × 10 ²	1 × 10 ⁻¹	1.01972	1	1.45038 × 10	7.50062 × 10 ²	2.953 × 10	9.86923 × 10 ⁻¹
1 psi	6.89473	6.89473 × 10 ⁻³	7.03065 × 10 ⁻²	6.89473 × 10 ⁻²	1	5.17147 × 10	2.036	6.80457 × 10 ⁻²
1 mmHg (1 Torr)	1.33322 × 10 ⁻¹	1.33322 × 10 ⁻⁴	1.35951 × 10 ⁻³	1.33322 × 10 ⁻³	1.93368 × 10 ⁻²	1	3.9370 × 10 ⁻²	1.31579 × 10 ⁻³
1 inHg	3.3864	3.3864 × 10 ⁻³	3.4531 × 10 ⁻²	3.3864 × 10 ⁻²	0.4912	2.5400 × 10	1	3.342 × 10 ⁻²
1 atm	1.01325 × 10 ²	1.01325 × 10 ⁻¹	1.03323	1.01325	1.46960 × 10	7.60000 × 10 ²	2.9921 × 10	1

The Effect of Altitude (Atmospheric Pressure) on Maximum Attainable Vacuum Level

The Maximum Possible Vacuum Attained is based on your Altitude. Basically, the higher you are the less vacuum you can attain. Because free air is less dense at higher altitudes (i.e. lower atmospheric pressure) operation at these higher altitudes has the effect of reducing the capacity and maximum vacuum levels attainable. In general flow is not affected, just the maximum vacuum level attainable.

It is also important to consider the relationship between atmospheric pressure and altitude as it affects vacuum pump performance.

Refer to the following table to correct for vacuum pump performance at various altitudes.

Vacuum Gauge Reading When Read at Altitude

Altitude Above Sea Level (Feet)	Altitude Above Sea Level (Meters)	Atmospheric Pressure (psi)	Maximum Vacuum Level Attainable (inches Hg)	Vacuum Level Loss at Altitude	Maximum Vacuum Level Possible at this Altitude
0'	0 M	14.70 psi	29.921" Hg	-	-
1000'	305 M	14.16 psi	28.9" Hg	3.4%	96.6%
2000'	610 M	13.66 psi	27.8" Hg	7.1%	92.9%
3000'	914 M	13.16 psi	26.8" Hg	10.4%	89.6%
4000'	1219 M	12.68 psi	25.8" Hg	13.8%	86.2%
5000'	1524 M	12.22 psi	24.9" Hg	16.8%	83.2%
6000'	1829 M	11.77 psi	24.0" Hg	19.8%	80.2%
7000'	2134 M	11.33 psi	23.1" Hg	22.8%	77.2%
8000'	2438 M	10.91 psi	22.2" Hg	25.9%	74.1%
9000'	2743 M	10.50 psi	21.4" Hg	28.6%	71.4%
10,000'	3048 M	10.10 psi	20.6" Hg	31.3%	68.7%
11,000'	3353 M	9.71 psi	19.8" Hg	33.9%	66.1%
12,000'	3658 M	9.34 psi	19.0" Hg	36.5%	63.5%
13,000'	3962 M	8.97 psi	18.3" Hg	39.0%	61.0%
14,000'	4267 M	8.62 psi	17.5" Hg	41.4%	58.6%
15,000'	4752 M	8.28 psi	16.9" Hg	43.6%	56.4%